

User's Manual

HDMI-CEC

Demonstration Board

CEC-78K0R/KG3C

Windows and Windows XP are registered trademarks or trademarks of Microsoft Corporation in the United States and/or other countries.

- The information in this document is subject to change without notice.
- No part of this document may be copied or reproduced in any form or by any means without prior written consent of Tessera Technology Inc.
- Tessera Technology Inc. does not license assurance or enforcement of intellectual property rights and other rights of Tessera Technology Inc. and third parties by the use of the products and/or the information in this document. Tessera Technology Inc. does not assume any liability for infringement of rights of third parties by the use of the products and/or the information in this document.
- Descriptions of circuits, software and other related information in this document are provided for illustrative purposes in semiconductor product operation and application examples. The incorporation of these circuits, software and information in the design of a customer's equipment shall be done under the full responsibility of the customer. Tessera Technology Inc. assumes no responsibility for any losses incurred by customers or third parties arising from the use of these circuits, software and information.

CAUTION

- Do not give any physical damage to this equipment such as dropping
- Do not superimpose voltage to this equipment.
- Do not use this equipment with the temperature below 0°C or over 40°C.
- Make sure the USB cables are properly connected.
- Do not bend or stretch the USB cables.
- Keep this equipment away from water.
- Take extra care to electric shock.
- This equipment should be handled like a CMOS semiconductor device. The user must take all precautions to avoid build-up of static electricity while working with this equipment.
- All test and measurement tool including the workbench must be grounded.
- The user/operator must be grounded using the wrist strap.
- The connectors and/or device pins should not be touched with bare hands.

INTRODUCTION

CEC-78K0R/KG3C is designed for users who wish to evaluate HDMI-CEC features with 16-bit microcontroller 78K0R/Kx3-C series from Renesas Electronics.

It is assumed that the readers have been familiar with basics of HDMI and CEC. The overview and terms are available at "High-Definition Multimedia Interface Specification" in the following web site.

<http://www.hdmi.org/manufacturer/specification.aspx>

Please use the system with all necessary tests. Tessera Technology Inc. assumes no responsibility for any losses from the use of CEC-78K0R/KG3C.

TABLE OF CONTENTS

1. CEC-78K0R/KG3C	5
1.1 Features	5
1.2 Hardware Structure	5
1.3 Hardware Specifications	6
1.4 Layout of Hardware Functions	7
1.5 Hardware Functions	8
1.5.1 HDMI-CEC Demonstration Board	8
1.5.2 TK-78K0R/KG3C Board	9
1.6 Pin Function List.....	11
1.7 Circuit Diagram	12
2. SETTINGS FOR SAMPLE DEMONSTRATION PROGRAM.....	14
2.1 KEY Settings.....	14
2.2 LED Settings	15
3. GUI.....	16
3.1 CEC Viewer Functions	16
3.2 CEC Viewer Files	16
3.3 Connection Example	17
3.3.1 Example 1: Monitor Mode	17
3.3.2 Example 2: Pseudo DVR Mode / Pseudo TV Mode.....	18
3.4 CEC Viewer Window	19
3.4.1 Window Overview	19
3.4.2 "File" Menu	20
3.4.3 "Menu" Menu	21
3.4.4 "Debug" Menu.....	22
3.5 Control From CEC Viewer.....	23
3.5.1 "Monitor" Tab	23
3.5.2 "Replay" Tab	25
3.6 Specific Usages	26
3.6.1 Switch Settings	26
3.6.2 Use As Monitor	27
3.6.3 Pseudo Device Sample Program	28
3.6.4 Replay Function	29
4. DDC MONITOR.....	31
4.1 Monitoring DDC on GUI	31

1. CEC-78K0R/KG3C

In this chapter, features and hardware specifications of CEC-78K0R/KG3C, 16-bit microcontroller 78K0R/Kx3-C series from Renesas Electronics, are described.

1.1 Features

CEC-78K0R/KG3C has following features.

- 2 HDMI channels
- 10 general purpose key inputs (AD input)
- Infrared remote control function
- MINICUBE2 connection (on-chip debug, writing on flash memory)
- USB connection with PC
- 2 7segLED
- 15x6 holes universal area

1.2 Hardware Structure

CEC-78K0R/KG3C is a combined product of TK-78K0R/KG3C and HDMI-CEC Demonstration Board.

TK-78K0R/KG3C



HDMI-CEC Demonstration Board



Following connectors are mounted.

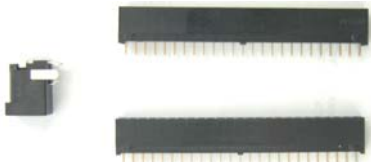

1.3 Hardware Specifications

CPU	uPD78F1849A (78K0R/KG3-C)
Clock	Main system clock: 20MHz, Sub system clock: 32.768KHz
Interface	HDMI connector 2ch MINICUBE2 connector (16pin) USB (mini B connector)
Operating Voltage	3.3V (DC 12V input)

1.4 Layout of Hardware Functions

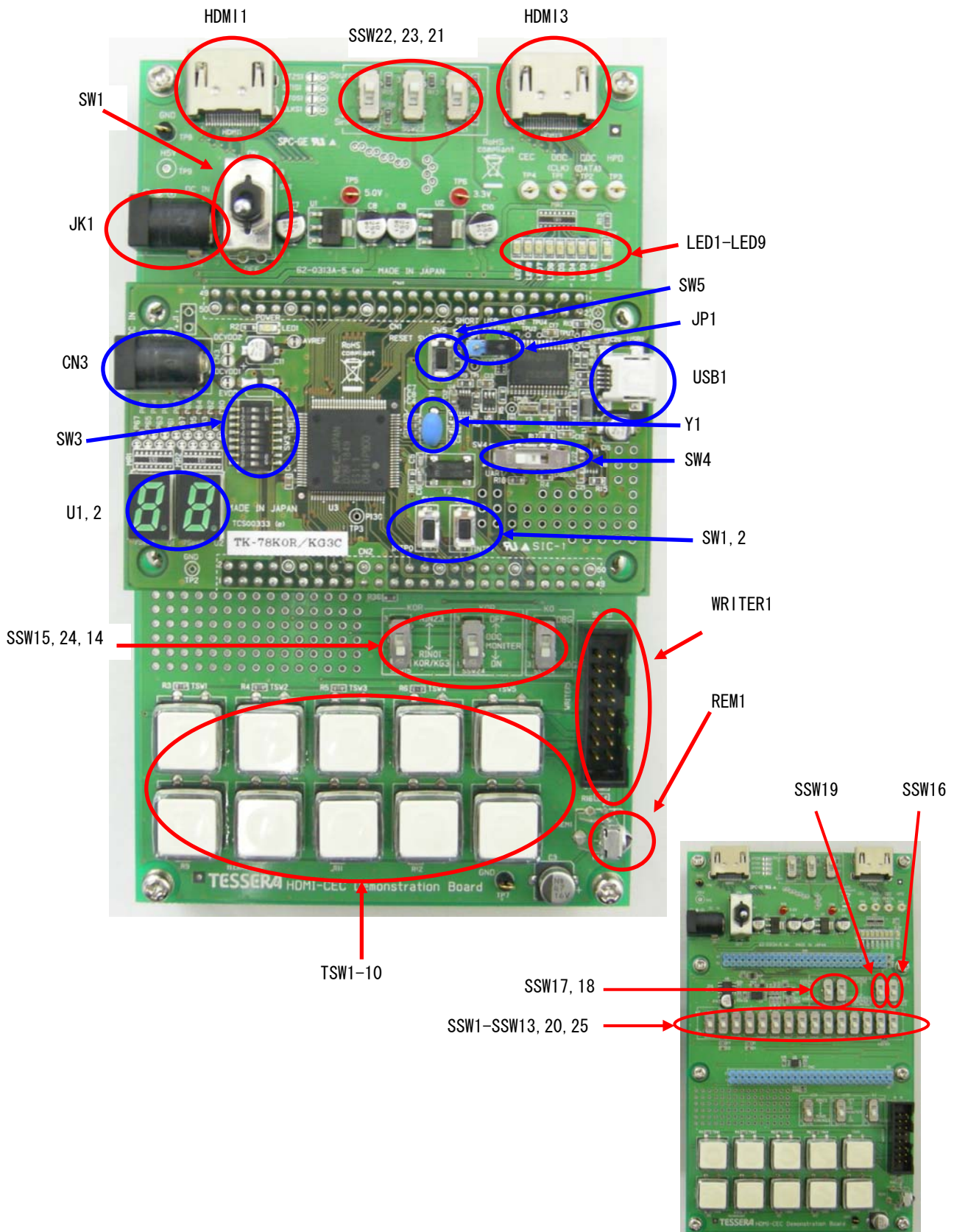

1.5 Hardware Functions

1.5.1 HDMI-CEC Demonstration Board

- HDMI1, HDMI3
They are HDMI connectors. All the pins of HDMI1 and HDMI3 are connected.
- JK1
JK1 is a connector for AC adapter. Connect the bundled AC adapter here.
- SW1
SW1 is the power switch. Power on when you shift it to ON and then LED1 is lighted.
- LED1
LED1 is Power LED. It is lighted when the power is on.
- LED2-LED9
These are LED that are connected to P7 of CPU. They are lighted when they output Low.
- SSW1-SSW13,20,25
All those 15 switches must be set to "78K0R" side. (default setting)
- SSW14
Not is use.
- SSW15
This must be set to "RIN01 K0R/KG3" side. (default setting)
- SSW16
This must be set to "K0R/KG3-C" side. (default setting)
- SSW17,18
These must be set to "K0R/KG3-C CECIN/OUT" side. (default setting)
- SSW19
This must be set to "K0R/KG3-C CECIO" side. (default setting)
- SSW21-SSW23
These are extended switched for HPD and DDC. Switch them with "Source" or "Sink".
 - > Set it to "Source" when you use as Monitor mode.
 - > Set it to "Sink" when you use as Pseudo TV mode.
 - > Set it to "Source" when you use as Pseudo DVR mode.

- SSW24
Set this to "ON" when you monitor DDC. (default setting)
- TSW1-TSW10
These are use as inputs for general purpose switches. They are connected to A/D conversion ports.
By pressing the switches, following voltages are input.

Switch	CPU Pin	CPU Input Voltage	Switch	CPU Pin	CPU Input Voltage
TSW1	ANI2	0V	TSW6	ANI3	0V
TSW2	ANI2	0.51V	TSW7	ANI3	0.51V
TSW3	ANI2	0.96V	TSW8	ANI3	0.96V
TSW4	ANI2	1.41V	TSW9	ANI3	1.41V
TSW5	ANI2	1.88V	TSW10	ANI3	1.88V

- WRITER1
This is MINICUBE2 connector.
- REM1
This is the light receiving element for infrared remote control function.

1.5.2 TK-78K0R/KG3C Board

In this section, the hardware functions are briefly described. For details, refer to "TK-78K0R/KG3C User's Manual".

- CN3
This is a connector for AC adapter, but not in use. Use the JK1 AC adapter connector on HDMI-CEC Demonstration Board.
- SW1
SW1 is a push-switch that is connected to P120 of CPU.
- SW2
SW2 is a push-switch that is connected to P46. However, it cannot be used as it is connected to infrared remote control function. Do not touch when application is running.
- U1,2
This is 7segLED. U2 is connected to P8.
U1 is connected with the terminal P6 of CPU by way of the solder short putt. This solder short putt cannot light U1 with CEC-78K0R/KG3C because it has cut it.
- JP1
JP1 sets the CPU power selection. Set this as open. (default setting)
- USB1
This is a USB connector. Use bundled USB cable.

- SW3-1,SW3-2,SW3-3,SW4

These are used as setting the operation mode.

Switch		MINICUBE2 is Connected CEC Viewer is in Use (default setting)	Debugger ID78K0R-QB-EZ is in Use Flash Programmer WriteEZ4 is in Use (bundled with TK-78K0R/KG3C)
SW3	1	OFF	ON
	2	OFF	ON
	3	OFF	ON
SW4		UART	Debug

- SW3-4 - SW3-8

These are connected to P50,51,52,53,54 of CPU.

- SW5

This is the CPU reset switch.

- Y1

This is the CPU operation clock. Do not change this from default setting, 20MHz. The sample program will not work if it is changed.

1.6 Pin Function List

CN1	Pin Name	Used For
1	AVREF	
2	GND	
3	P30	
4	P04	
5	VDD	
6	P60	DDC(CLK)
7	P61	DDC(DATA)
8	FLMD0	Connect to WRITE1 Connector(16Pin)
9	VDD	3.3V
10	(+12V)	
11	GND	GND
12	(+12V)	
13	VDD	3.3V
14	RESET	Connect to WRITE1 Connector(16Pin)
15	VDD	3.3V
16	(+12V)	
17	P64	
18	P65	
19	P66	
20	P67	
21	P140	
22	P11	
23	P01	
24	P12	
25	P06	
26	P05	
27	P80	7segLED
28	P16	DDC(DATA) Monitor
29	P17	
30	P31	Connect to Over Current(+5V)
31	P81	
32	P82	
33	GND	GND
34	EVDD	
35	P83	
36	P84	7segLED
37	P70	LED2
38	P71	LED3
39	P72	LED4
40	P73	LED5
41	P74	LED6
42	P75	LED7
43	P76	LED8
44	P77	LED9
45	P85	7segLED
46	P86	7segLED
47	P87	7segLED
48	P50	DipSW(SW3-4)
49	P51	DipSW(SW3-5)
50	P52	DipSW(SW3-6)

CN2	Pin Name	Used For
1	P20	
2	P21	
3	P22	KEY input (KEY1~5)
4	P23	KEY input (KEY6~10)
5	P00	
6	P131	
7	P145	
8	P53	DipSW(SW3-7)
9	P57	
10	P43	
11	P15	
12	P14	
13	P13	
14	P10	
15	P111	CEC-OUT Output
16	P45	
17	P44	
18	P27	
19	GND	GND
20	EVDD	
21	P54	DipSW(SW3-8)
22	P55	
23	P56	
24	P02	
25	P91	
26	P42	
27	P154	
28	P120	
29	P144	
30	P143	
31	P142	
32	P141	
33	P47	Connect to Remote Control Module(RIN23)
34	P46	Connect to Remote Control Module(RIN01)
35	P41	Connect to WRITE1 Connector(16Pin)
36	P40	Connect to WRITE1 Connector(16Pin)
37	P26	
38	P25	
39	P24	
40	P03	
41	P62	CEC
42	P63	HPD
43	P153	
44	P152	
45	P151	
46	P150	
47	P110	CEC-IN input
48	P157	
49	P156	
50	P155	

1.7 Circuit Diagram

Please refer to product version CD.

Please refer to product version CD.

2. Settings for Sample Demonstration Program

2.1 KEY Settings

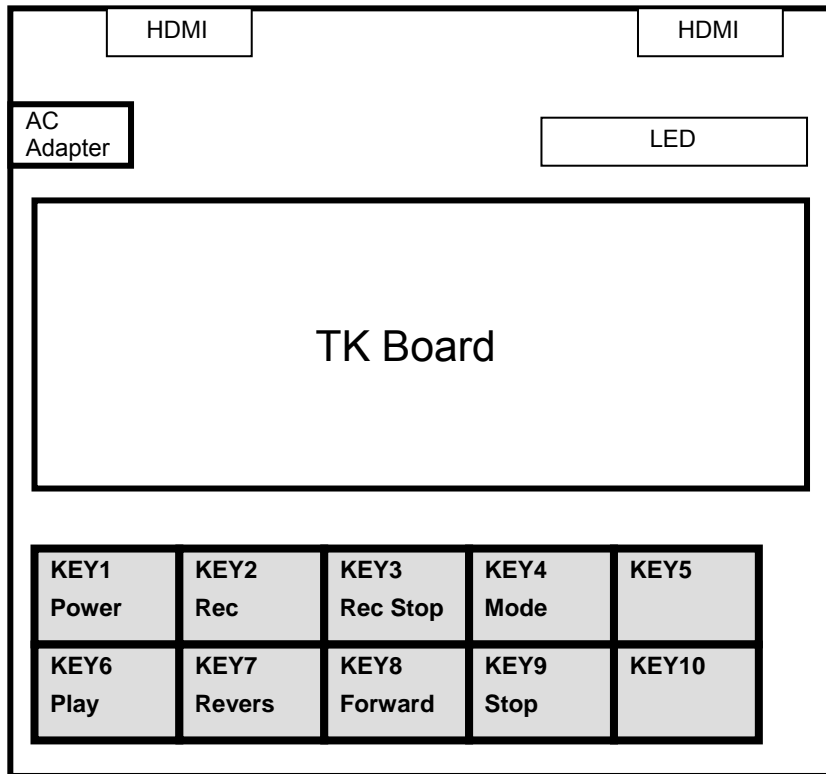

KEY	Used For
KEY1	Power
KEY2	Record
KEY3	Record Stop
KEY4	Mode Change (Monitor Mode at startup) Push to change the mode, "Pseudo TV"(LED9 light), "Pseudo DVR"(LED8 light), "Pseudo TV"(LED9 blinking), "Pseudo DVR"(LED8 blinking), "Monitor". Please evaluate it by the combination in blinking in lighting when evaluating it with the board.
KEY5	(Not in use)
KEY6	Play
KEY7	Rewind
KEY8	Fast-forward
KEY9	Stop
KEY10	Select Remote Controller Display (Remote Controller Code / Key Name)

2.2 LED Settings

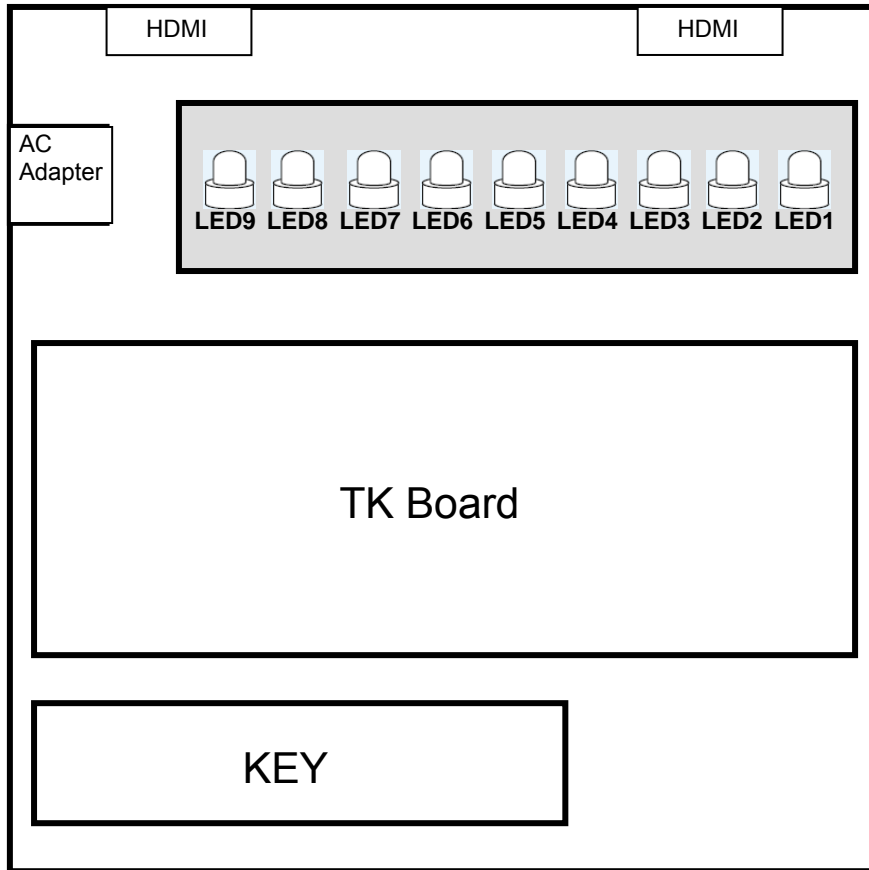

LED	Used For
LED1(green)	Lighted when the board power is on.
LED2(red)	Pseudo device power
LED3(red)	Playing
LED4(red)	Fast-forwarding
LED5(red)	Reversing
LED6(red)	Recording
LED7(red)	
LED8(red)	Pseudo DVR mode
LED9(red)	Pseudo TV mode
LED Scroll	Monitor mode

3. GUI

In this chapter, GUI to control CEC of HDMI from PC (CEC Viewer) is described.

- The sample program (78K0R_Kx3-C.hex) is pre-installed on the TK-78K0R/KG3C.
If you wrote other programs on the system, you can write the sample program (78K0R_Kx3-C.hex) again by using following tools.
 - Flash memory programmer "WriteEZ4" that you can find in bundled CD-ROM.
 - Flash memory programmer for MINICUBE2 "QB-Programmer" or debugger "ID78K0R-QB".
- This sample program works only if 20MHz oscillator is mounted on TK-78K0R/KG3C.
- The remote control receiving function of this sample program (78K0R_Kx3-C.hex) supports only NEC format.
- CEC Viewer works with Microsoft Excel. (operation check has been done on Excel 2000 and Excel 2003)

3.1 CEC Viewer Functions

CEC Viewer has following functions.

- Monitor sending/receiving CEC data
- Send specific commands from user input
- Pre-set command data, 20 KEY
- Output log data with Excel format
- Reproducing function by loading log data with Excel format

3.2 CEC Viewer Files

File	Description
CECViewer.exe	Start CEC Viewer by executing this file.
command.xls	CEC command (Opcode) data file. With using this file, you can add new Opcode. Since the program retrieves the command data from this file, do not close this file while CEC Viewer is running.
cecviewer.ini	Pre-set key data that is registered with GUI is stored in this file.

3.3 Connection Example

Connection examples of the board for using CEC Viewer are described.

3.3.1 Example 1: Monitor Mode

You can monitor the data communication between devices by connecting the devices through the board. Following figure shows the connection example to monitor the communication between TV and recording device.

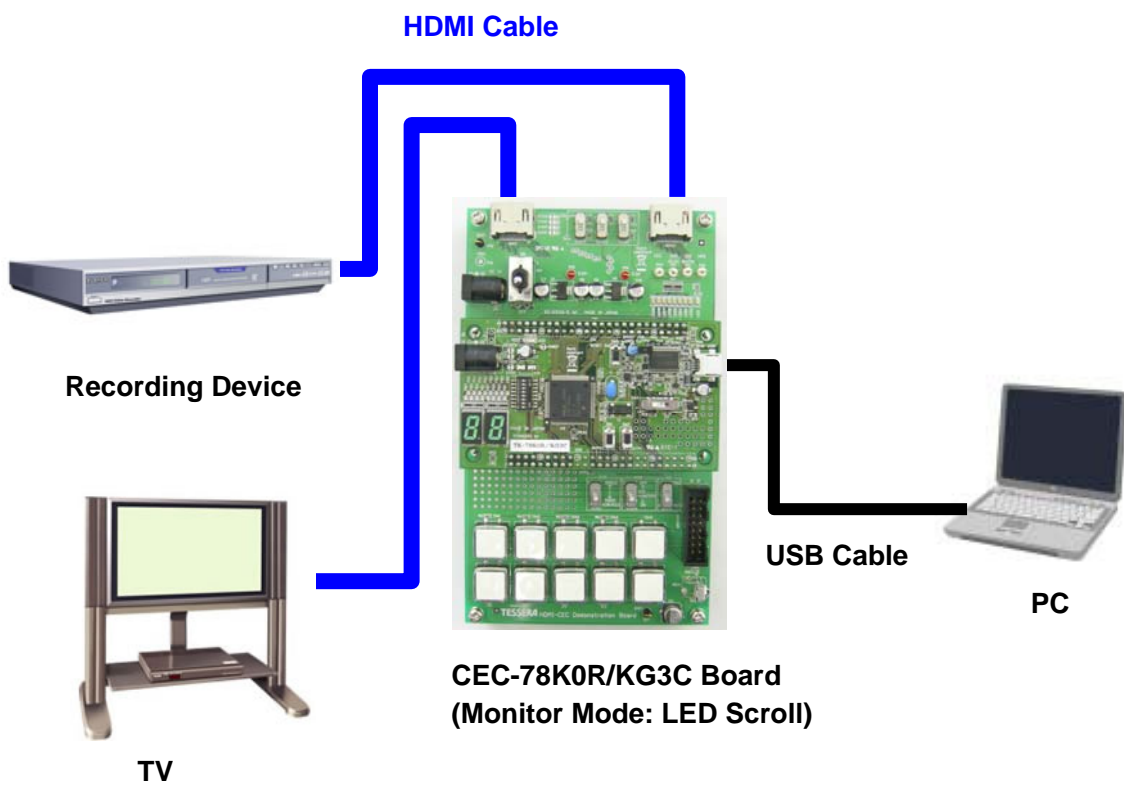

3.3.2 Example 2: Pseudo DVR Mode / Pseudo TV Mode

To operate the board as a pseudo DVR or TV, you need to connect the board to board together. You can reproduce functions, such as turning on the power of pseudo TV automatically by turning on the power of pseudo DVR, and turning off the power of pseudo DVR automatically by turning off the power of pseudo TV.

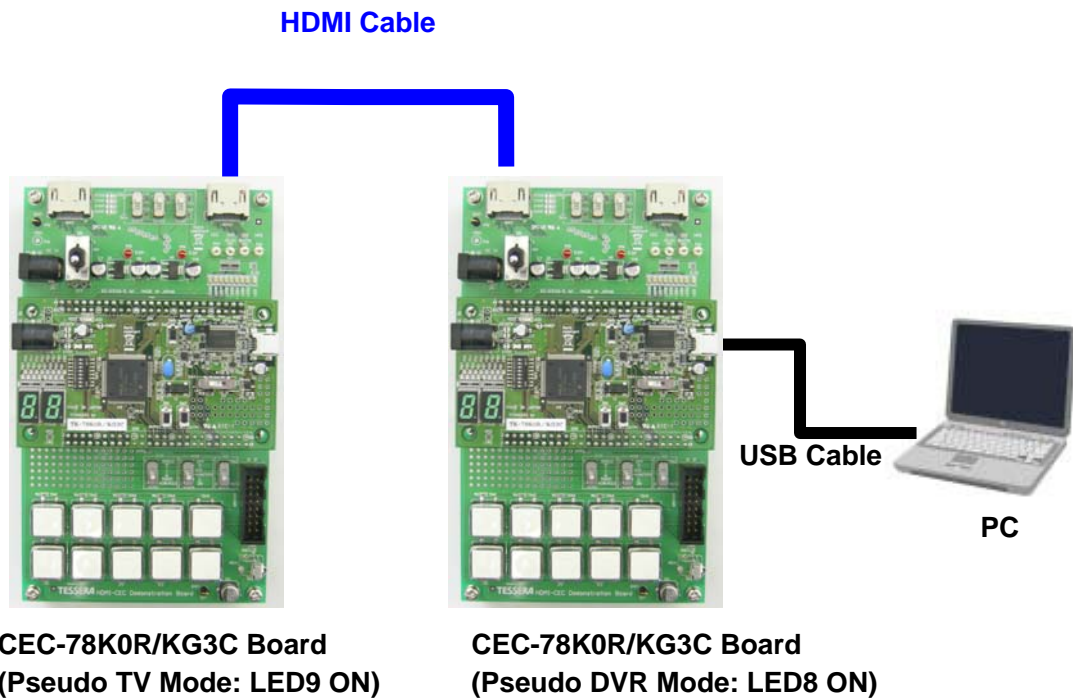

3.4 CEC Viewer Window

In this section, CEC Viewer window is explained.

3.4.1 Window Overview

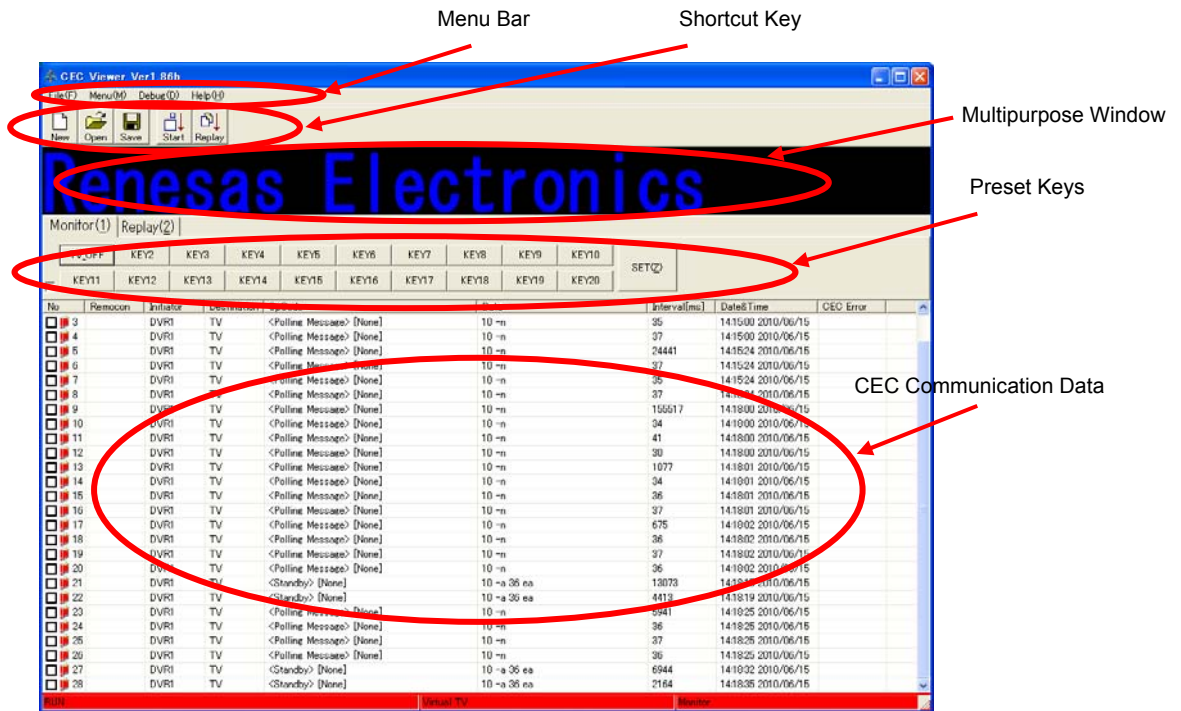





CEC Communication Data

No	Communication orders
Remocon	Remote controller code or remote controller code name
Initiator	Initiator Address name *
Destination	Destination Address name *
Opcode	Opcode name and its operand structure *
Data	Frame communication result It displays data on odd byte and EOM+ACK on even byte. It displays "e" when it has EOM, otherwise "-". It displays "a" when it has ACK, otherwise "n".
Interval[ms]	Interval time between CEC communication (or DDC communication offered as optional function)
Date & Time	Date and time when it gets the frame data

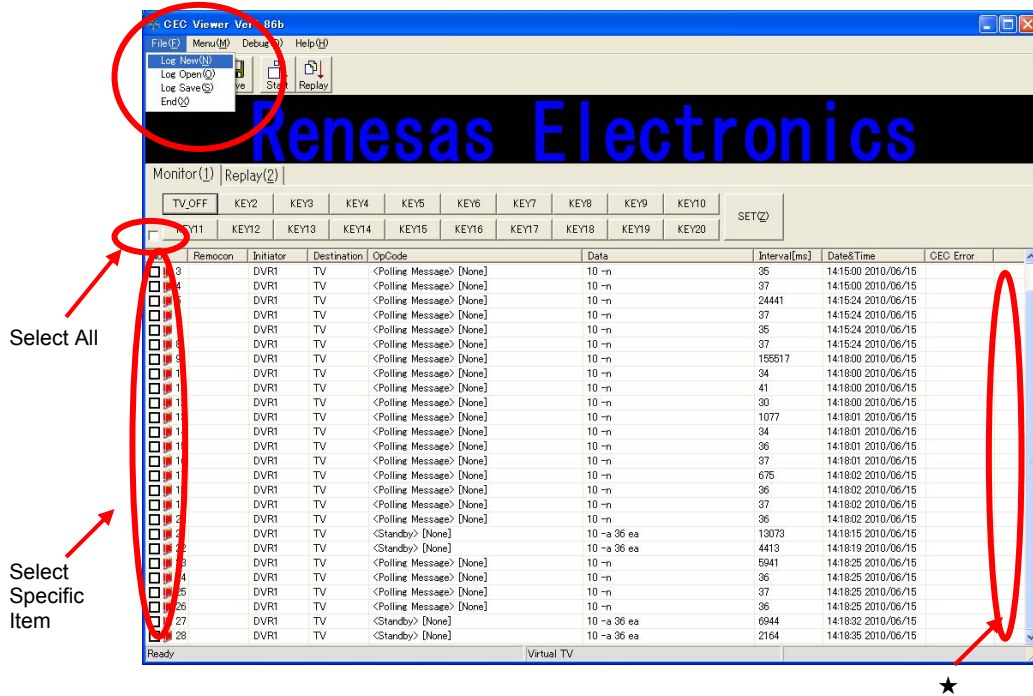
* It gets the information from "command.xls". If you close this file, it will not be able to display the logical address and Opcode.

3.4.2 "File" Menu



Log New	<p>Clear log data displaying.</p> <p>It is the same as the shortcut key  .</p>
Log Open	<p>This does not work with current version of CEC Viewer.</p> <p>It is the same as the shortcut key  .</p>
Log Save	<p>Save the current log data with Excel format.</p> <p>It is the same as the shortcut key  .</p> <p>*You can select specific rows by checking the check box.</p> <p>*You can select all rows by checking the check box above "No".</p> <p>Please select * on the No row again after clicking the area of * once when all not selecting it.</p>
End	<p>Close CEC Viewer.</p>

3.4.3 "Menu" Menu

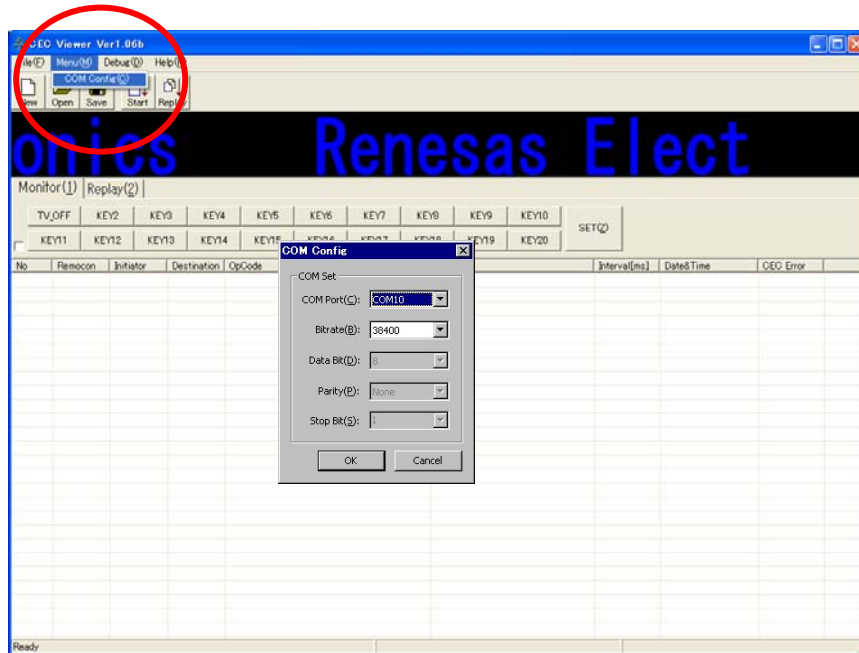



COM Config (Settings for UART communication)

COM Port	Select the COM port that is assigned for TK-78K0R/KG3C. (COM Port 1-19)
Bit rate	Select from 9600, 14400, 19200, 38400 (default), 57600, 115200, 128000. (Select the default setting, 38400)
Data Bit	Fixed with 8 bit.
Parity	Fixed with None.
Stop Bit	Fixed with 1 bit.

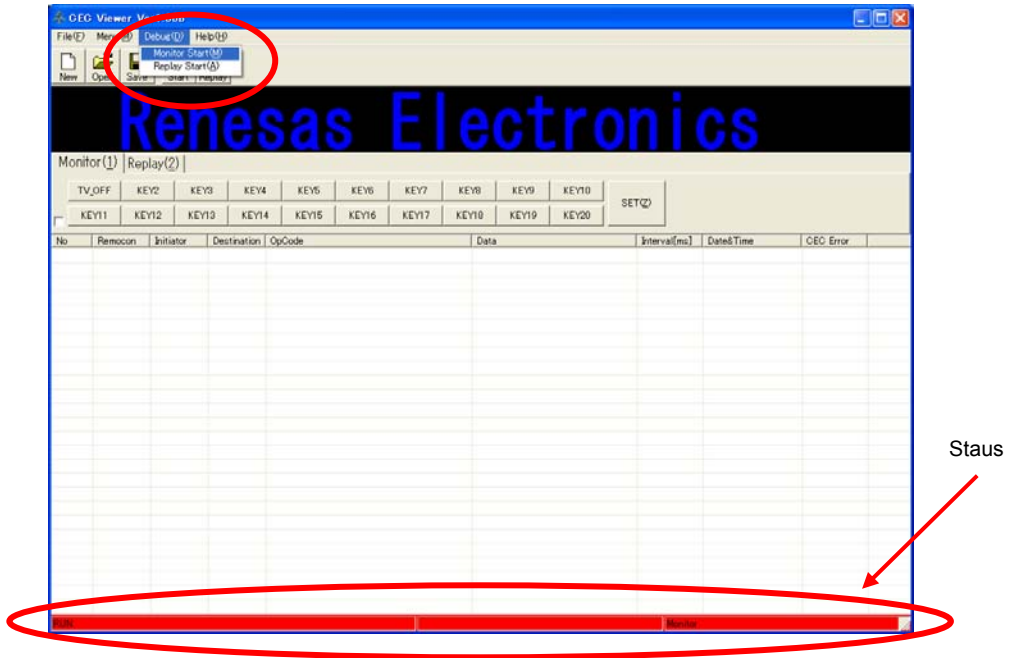
3.4.4 "Debug" Menu



<p>Monitor Start</p>	<p>Start monitoring CEC. When it starts monitoring, the bottom of the window becomes red color to show RUN status. Communication results are displayed only when the status bar shows RUN. Select this menu when you wish to monitor communication between devices or to send commands from CEC Viewer. To stop monitoring, select this menu again. It toggles like RUN, STOP, and RUN.</p> <p>It is the same as the shortcut key  .</p>
<p>Replay Start</p>	<p>Replay the CEC communication based on log data saved with Excel format. Set replay tag properly and execute. *For detail about replay function, refer to "3.6.4 Replay Function"</p> <p>It is the same as the shortcut key  .</p>

3.5 Control From CEC Viewer

CEC data can be sent from CEC Viewer.

3.5.1 "Monitor" Tab

It sends user defined CEC data from preset keys.

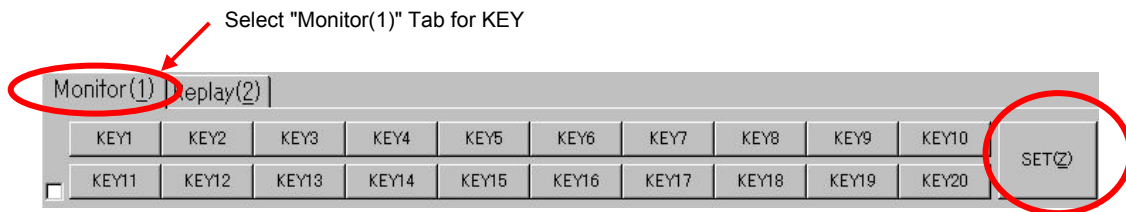

Following "Preset KEY Config" screen is displayed by clicking "SET" key.

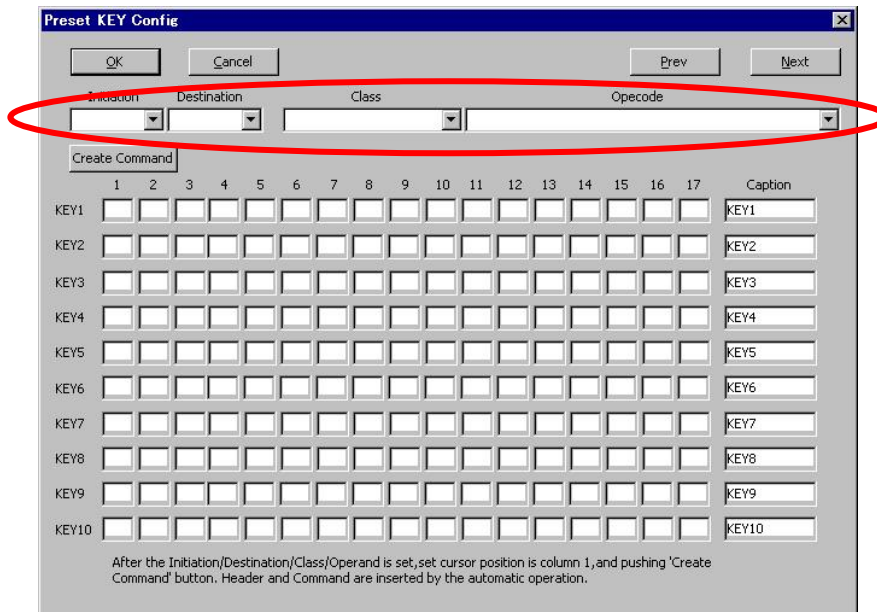

<KEY Setting>

Select Header and Opcode for the sending CEC data at combo box shown above red area. (You can also enter it at the KEY input area directly.)

1. Select sender's initiator address at "Initiation".
2. Select receiver's destination address at "Destination".
3. Select the class of sending Opcode at "Class".
4. Select Opcode at "Opcode"
5. Move the cursor at the first byte of specific KEY, and click "Create Command" key. Header and Opcode will be automatically set.
6. Enter Operand for Opcode at the KEY input area directory as needed.

Also, captions of KEY on CEC Viewer can be changed.
 Change the caption to "TV_OFF", then set the data [10] [36].

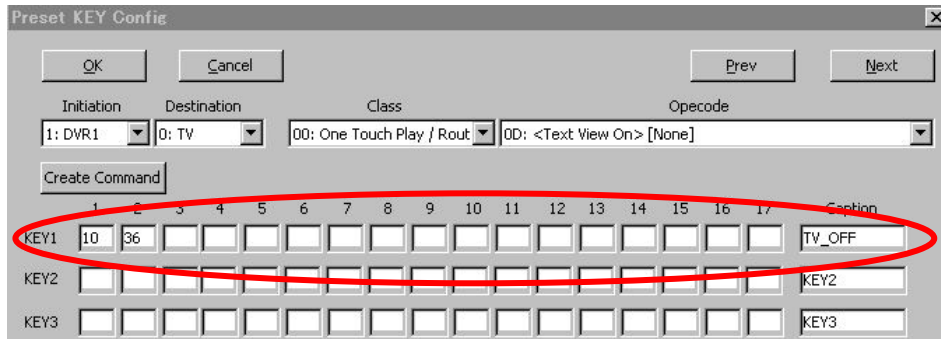

The caption of KEY1 is changed to "TV_OFF".

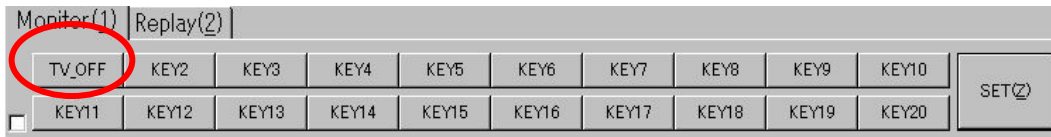

By clicking "TV_OFF" key, it outputs CEC data ([10][36]), then the log data is displayed.

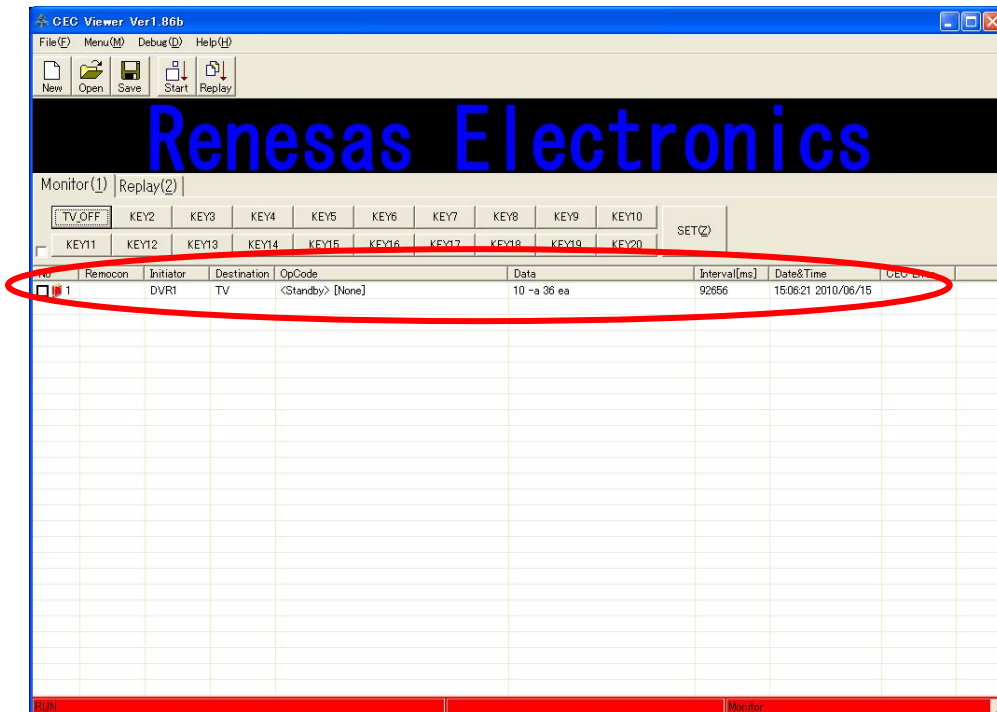

3.5.2 "Replay" Tab

It loads monitoring information, the board becomes a unit on the CEC, and then it replays the same CEC command communication.

For detail, refer to "3.6.4 Replay Function".

3.6 Specific Usages

3.6.1 Switch Settings

Set the switches as shown below.

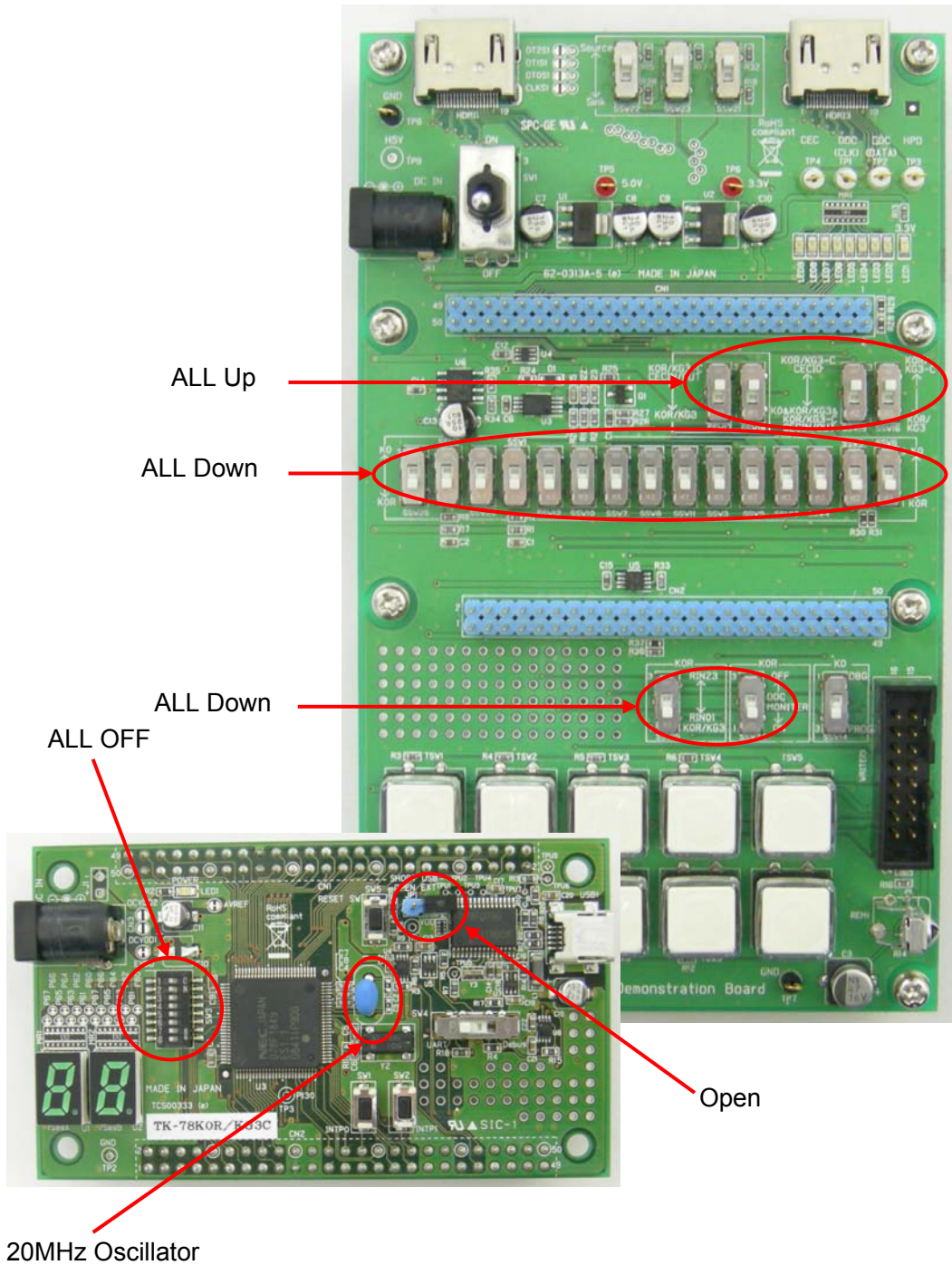

3.6.2 Use As Monitor

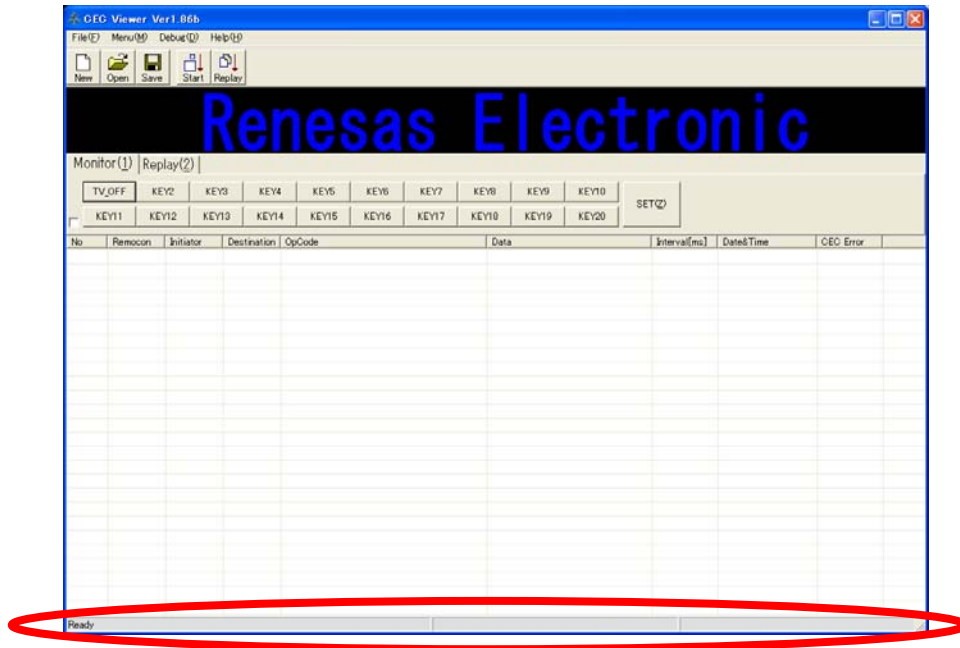

When CEC Viewer is just started, the color of status bar is white to show "Ready". At this status, it does not display any CEC data.

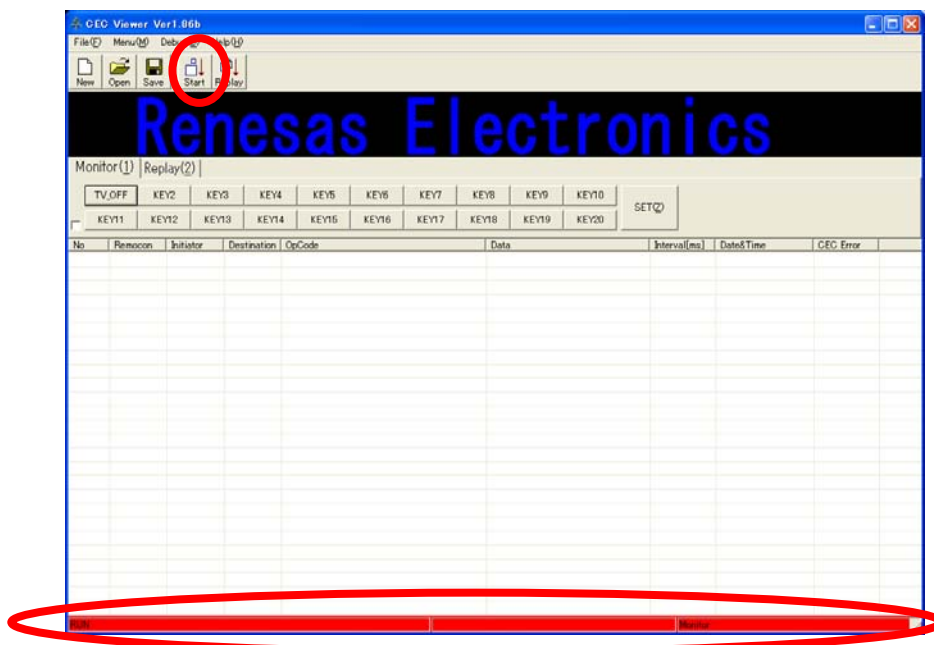

Click "Start" button to start monitoring by CEC Viewer.
The status bar becomes red to show "Run" status.
With this status, CEC communication data between the boards will be displayed.
Click "Start" button again to stop monitoring ("Ready" status).

3.6.3 Pseudo Device Sample Program

You just need to run CEC Viewer to use the Pseudo Device mode that is the same as Monitoring mode.

Click "TSW4(KEY4)" to select Pseudo Device (TV/DVR) mode. The multipurpose window displays the status of current pseudo device.



This is the example when you press power key with pseudo DVR mode. The multipurpose window displays "Power ON" to show the pseudo DVR is turned up.

Mode	Multipurpose Window	Status
Pseudo TV Mode	Power ON	Power ON
	Power OFF	Power OFF
	HDMI Input Change	TV input is switched to HDMI input
Pseudo DVR Mode	Power ON	Power ON
	Power OFF	Power OFF
	PLAY	Playing
	STOP	Stopped
	FORWARD	Fast-forwarding
	REVERSE	Rewinding
	REC	Recording
	REC STOP	Recording Stop
	PLAY(Recording)	Playing While Recording
	STOP(Recording)	Stopped While Recording
	FORWARD(Recording)	Fast-forwarding While Recording
REVERSE(Recording)	Rewinding While Recording	

3.6.4 Replay Function

1. Monitor replaying communication. Operation mode should be monitor mode (LED is scroll status on the board).
2. Select the saving rows from monitoring CEC communication data and check the check boxes. Then, click "Save" button to save the data in a file.

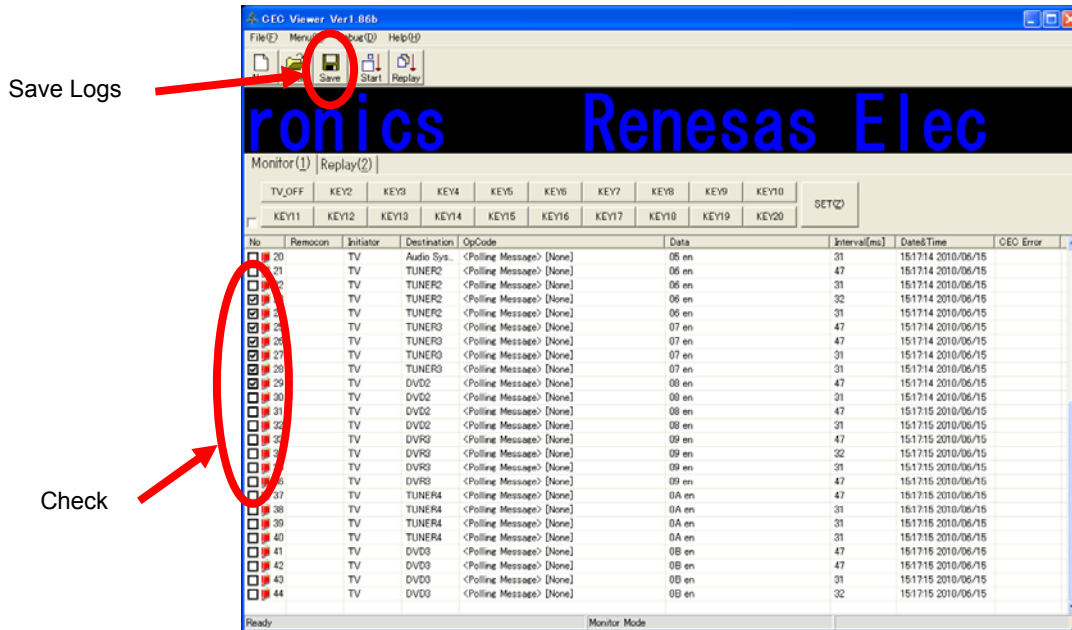

3. Next, replay the saved CEC communication data. Click "Open Script" button on "Replay" tab and select the log file that you have just saved before.

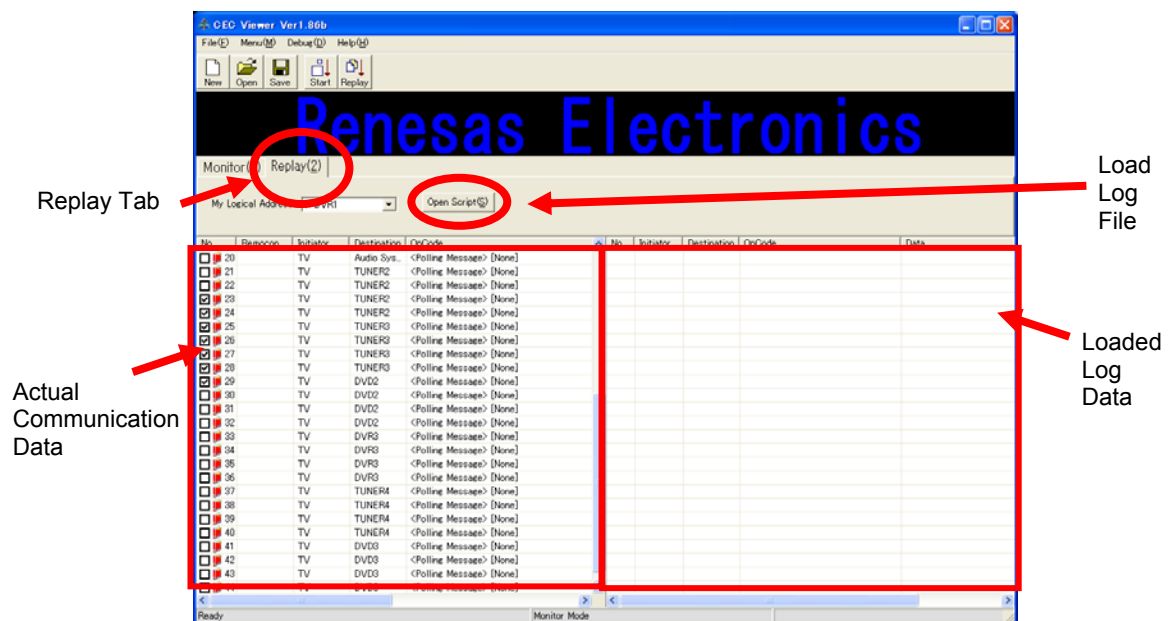

- Set the logical address to alternative address for the board. Specify the address at "My Logical Address".

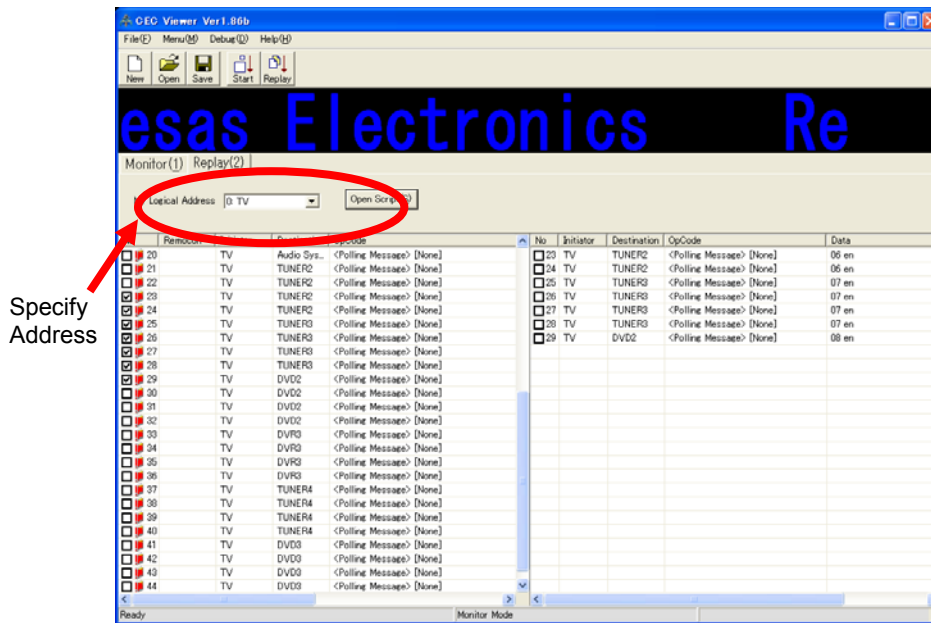

- The preparation for the replay process is completed. Now, you can start the replay by clicking "Replay" button.

* The replay operation will be terminated when it received the data that is different from the log data. Use the replay function with the same environment as the one when you save the log data.

<Example>

When you replay the TV power operation, make sure the elapsed time after you turned off the TV power is the same as the time in the log file.

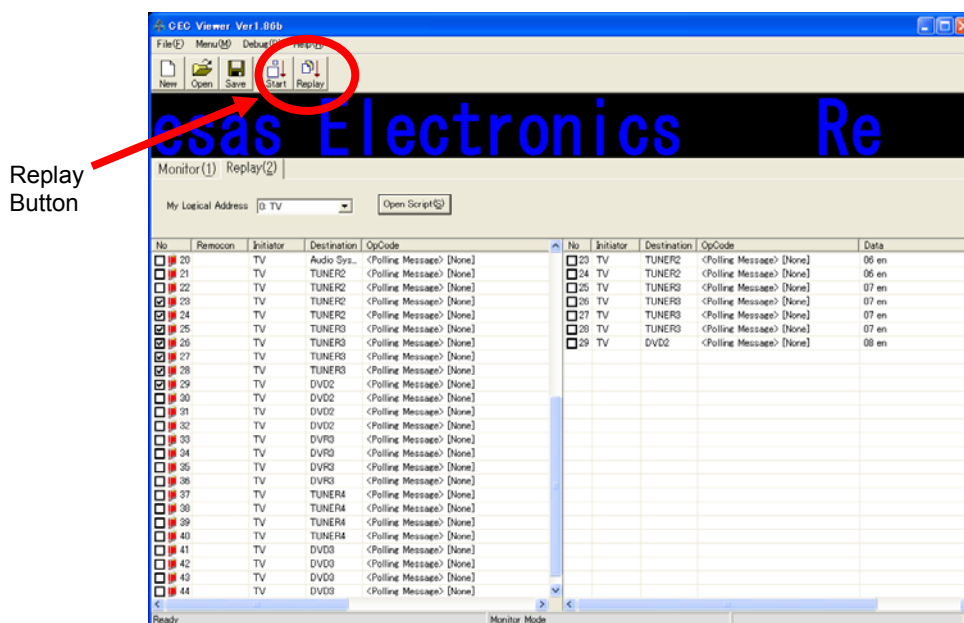

4. DDC Monitor

DDC data can be monitored on GUI by setting SSW24[DDC MONITOR] switch to ON.

4.1 Monitoring DDC on GUI

No special process is needed to monitor DDC on GUI.

Like CEC monitoring, click shortcut key  to start monitoring. It monitors both CEC and DDC data.

Row with  means that it is DDC data.

Row with  means that it is CEC data.

As the data format, it stores data on odd number rows and ACK/NACK on even number rows.

When it detects the Start Condition, it recognizes as the next data.

(Also, in the case of restarting that it does not get Stop Condition, it recognizes as the next data)

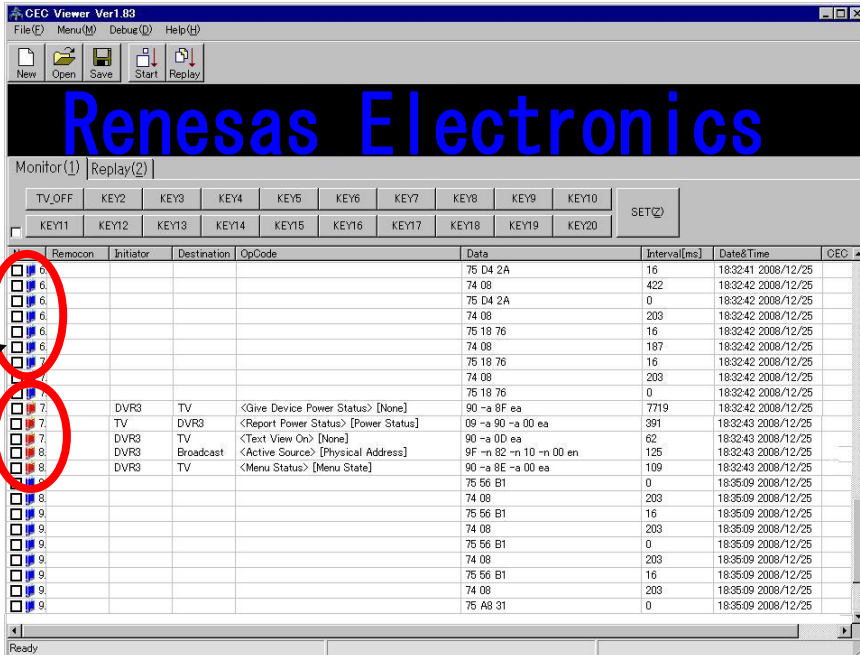

The screenshot shows the CEC Viewer Ver1.83 interface. The main data table is as follows:

Row	Remocon	Initiator	Destination	OpCode	Data	Interval[ms]	Date&Time	CEC
6					75 D4 2A	16	18:32:41 2008/12/25	
6					74 08	422	18:32:42 2008/12/25	
6					75 D4 2A	0	18:32:42 2008/12/25	
6					74 08	203	18:32:42 2008/12/25	
6					75 18 76	16	18:32:42 2008/12/25	
6					74 08	187	18:32:42 2008/12/25	
6					75 18 76	16	18:32:42 2008/12/25	
6					74 08	203	18:32:42 2008/12/25	
6					75 18 76	0	18:32:42 2008/12/25	
7	DVR3	TV		<Give Device Power Status> [None]	90 -a 8F ea	7719	18:32:42 2008/12/25	
7	TV	DVR3		<Report Power Status> [Power Status]	09 -a 80 -a 00 ea	391	18:32:43 2008/12/25	
7	DVR3	TV		<Text View On> [None]	90 -a 00 ea	62	18:32:43 2008/12/25	
8	DVR3	Broadcast		<Active Source> [Physical Address]	9F -n 82 -n 10 -n 00 en	125	18:32:43 2008/12/25	
8	DVR3	TV		<Menu Status> [Menu State]	90 -a 8E -a 00 ea	109	18:32:43 2008/12/25	
8					75 56 B1	0	18:35:09 2008/12/25	
8					74 08	203	18:35:09 2008/12/25	
9					75 56 B1	16	18:35:09 2008/12/25	
9					74 08	203	18:35:09 2008/12/25	
9					75 56 B1	0	18:35:09 2008/12/25	
9					74 08	203	18:35:09 2008/12/25	
9					75 56 B1	16	18:35:09 2008/12/25	
9					74 08	203	18:35:09 2008/12/25	
9					75 A8 31	0	18:35:09 2008/12/25	